

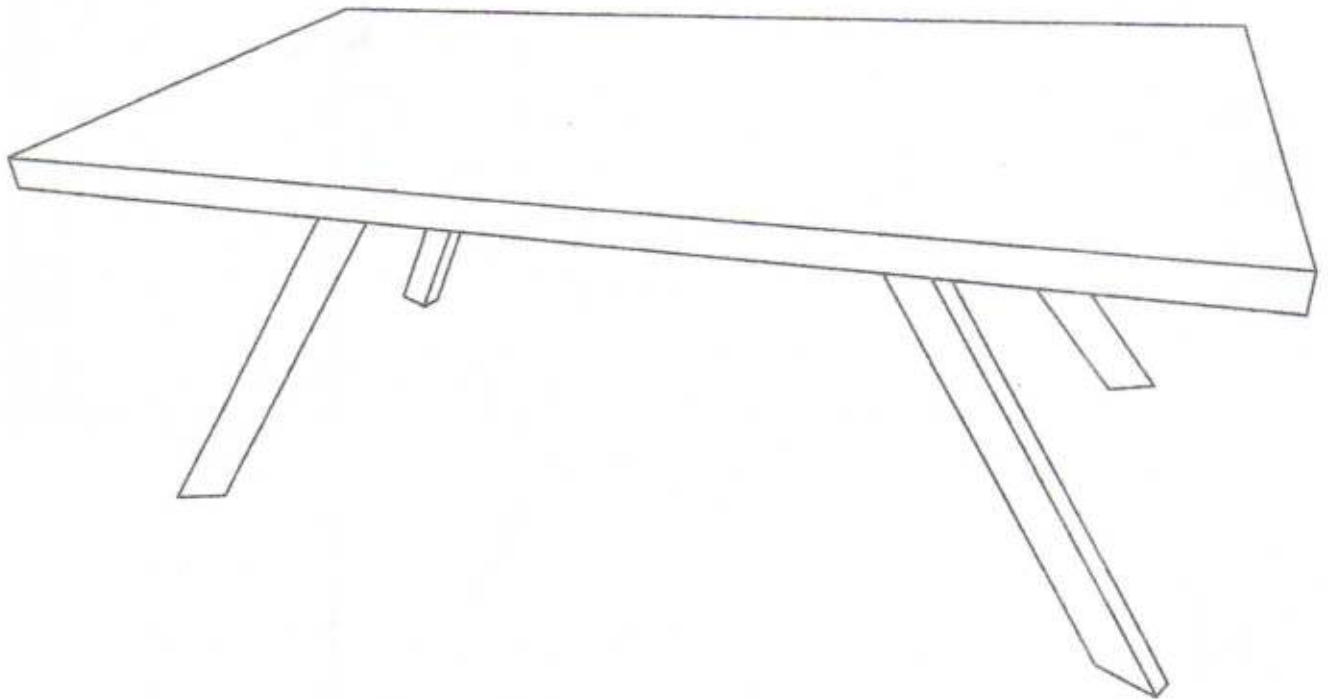





SOREN DINING TABLE ASSEMBLY INSTRUCTION



Tools Required

<p>a.</p>  <p>8 x screw M8 x12mm</p>	<p>b.</p>  <p>16 x screw M8 x25mm</p>	<p>c.</p>  <p>24 x washer M8 mm</p>	<p>d.</p>  <p>1x SPANNER 5 mm</p>
---	--	--	---

STOP!

Before you start...

1



Read Instructions carefully.

2



Lay out all of the components on a soft surface as if you were preparing to do a jigsaw puzzle.

3

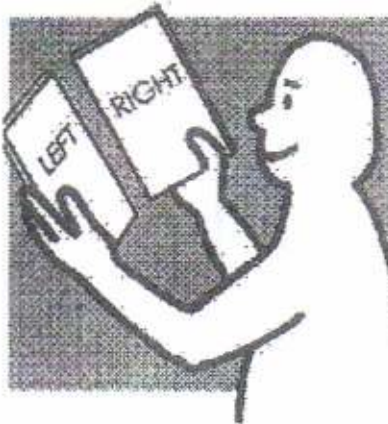

Carefully identify each component, especially those that are similar. The most common mistake is getting things back to front.

4

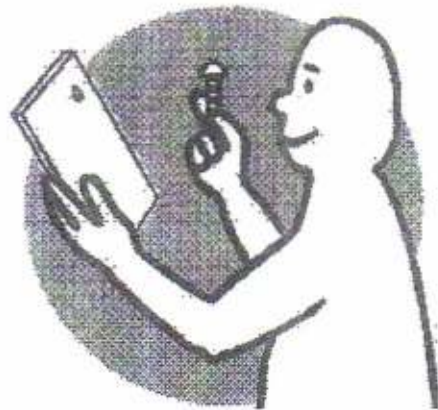

Separate and identify each component from the hardware pack—and rest each one in its proper location before fastening.

5

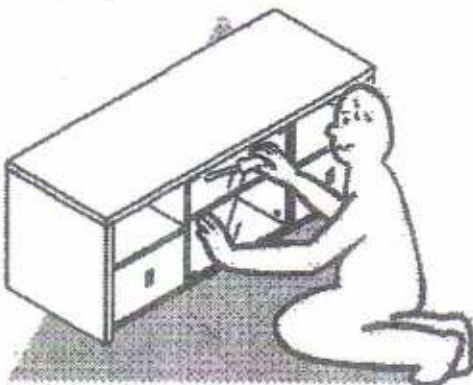

DO NOT Over-tighten screws

6





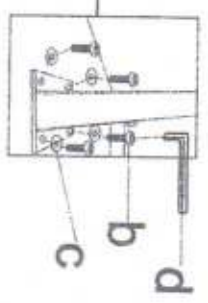
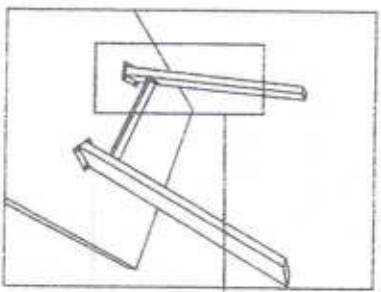
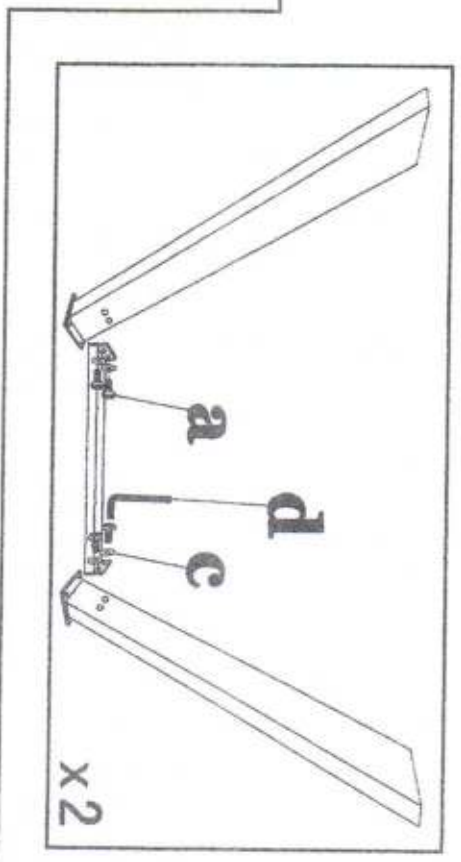
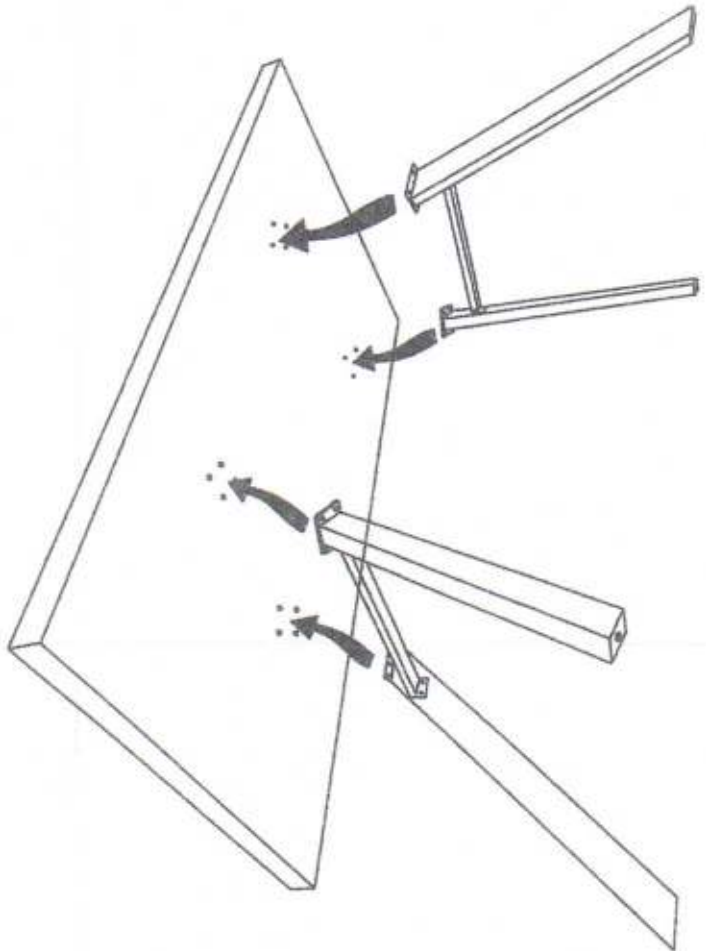

DO NOT set glue until you are certain that the parts belong together.

Step 1 : Attach frame with a (), c (), d (), as shown.

Step 2 : Attach leg to top with b (), c (), d (), as shown.



Tools Required

a.		b.		c.		d.	
	8 X SCREW M8 x12mm		16 X SCREW M8 x25mm		24 X WASHER M8 mm		1X SPANNER 5 mm



UNIT COMPLETE

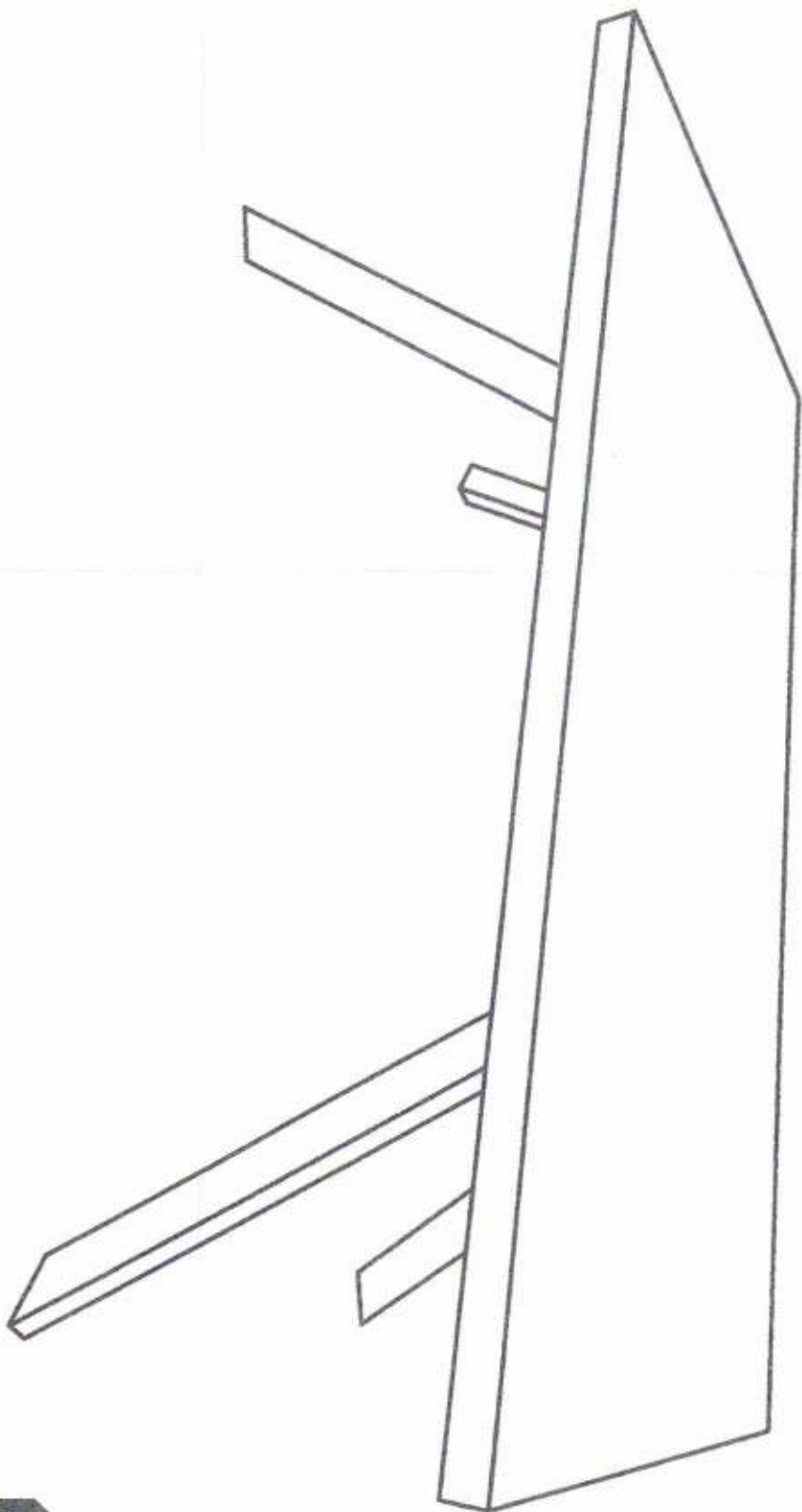

FURNITURE