



SOREN LAMP TABLE ASSEMBLY INSTRUCTIONS



Tools Required

a.



**8 x screw
M8X25mm**

b.



**8 x washer
M8mm**

c.



**1x SPANNER
5mm**

STOP!

Before you start...

1

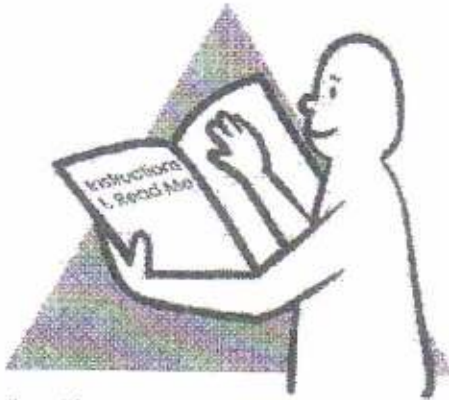

Read Instructions carefully.

2

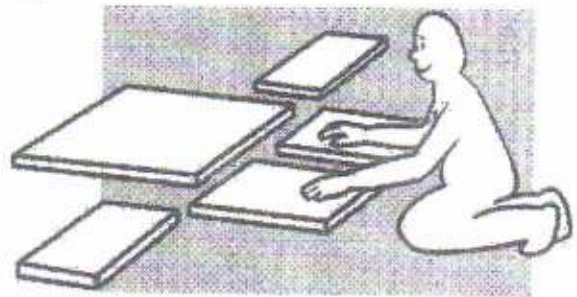

Lay out all of the components on a soft surface as if you were preparing to do a jigsaw puzzle.

3

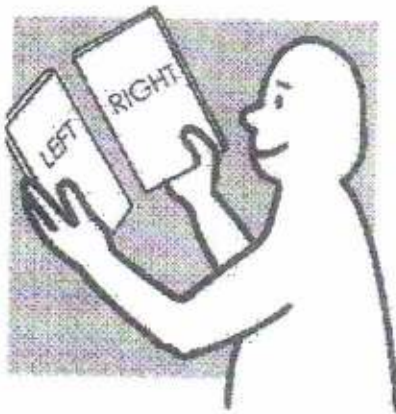

Carefully identify each component, especially those that are similar. The most common mistake is getting things back to front.

4

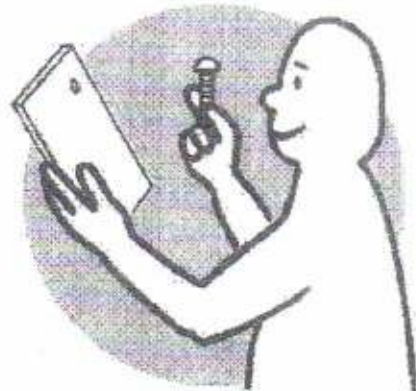

Separate and identify each component from the hardware pack— and rest each one in its proper location before fastening.

5

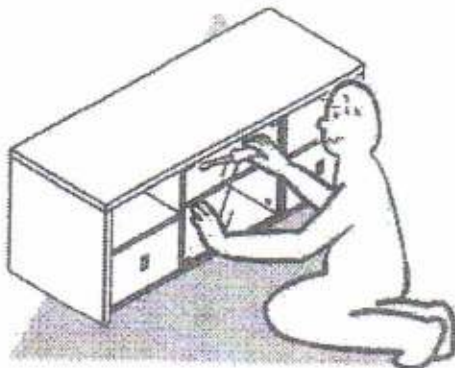

DO NOT Over-tighten screws

6

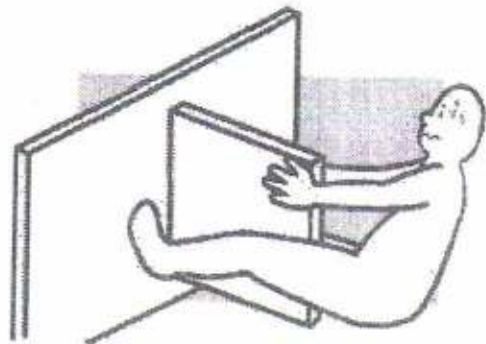

DO NOT set glue until you are certain that the parts belong together.

Step 1 : Attach leg to top with a (), b (), c (), as shown.

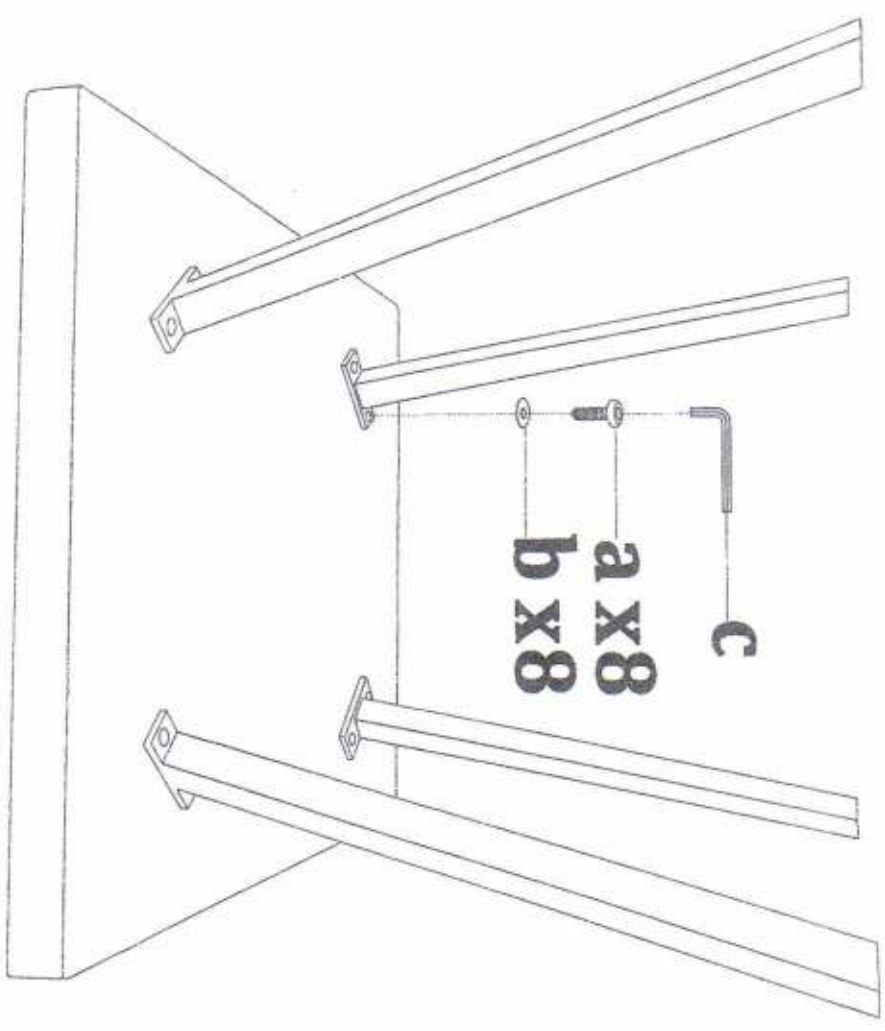

Tools Required

<p>a. </p> <p>8 X SCREW M8X25mm</p>	<p>b. </p> <p>8 X washer M8mm</p>	<p>c. </p> <p>1x SPANNER 5mm</p>
--	--	---

UNIT COMPLETE

