

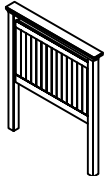

# ASSEMBLY INSTRUCTION





LV-2016-186-BED

Thank you for purchasing this quality product. Be sure to check all packing material carefully for small parts that may have come loose inside the carton during shipment.

## COMPONENT LISTS

NO	DESCRIPTION	QTY
1	 Headboard	1
2	 Footboard	1
3	 Side Rail	2

## HARDWARE LISTS

NO	DESCRIPTION	QTY
A	 Wrench	1
B	 Hexagon Bolt 15mm	8
C	 Flat Washer	8
D	 L Bracket	4
E	 Csk screw M3.5 X 16mm	20

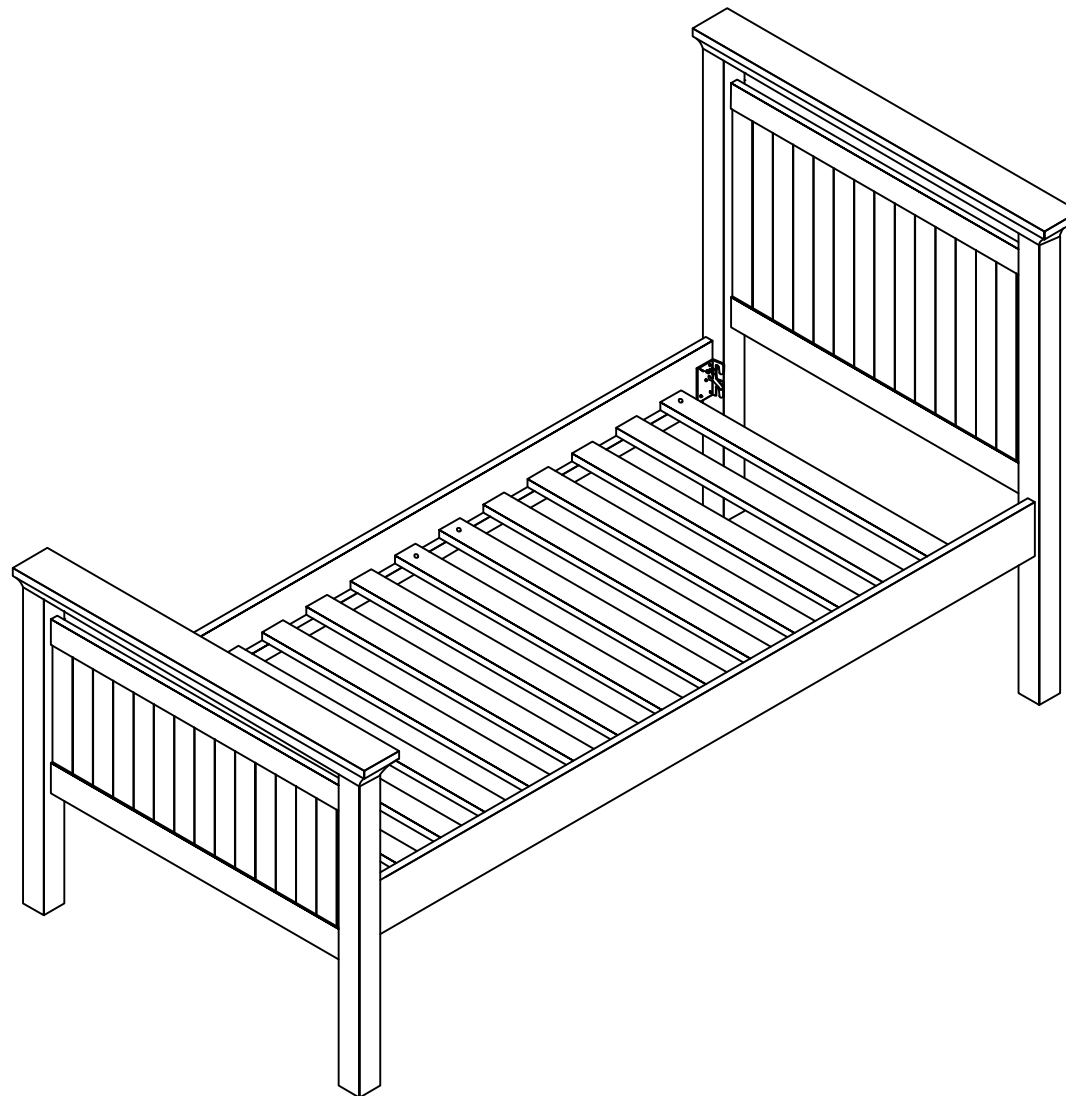

EXAMPLE FOR SKETCH ONLY

MADE IN MALAYSIA

# ASSEMBLY INSTRUCTION

LV-2016-186-BED

Thank you for purchasing this quality product. Be sure to check all packing material carefully for small parts that may have come loose inside the carton during shipment.

## STEP 1

FIX THE SIDE RAIL WITH HEXAGON BOLT BY USING THE WRENCH AS PER ATTACHED BELOW.

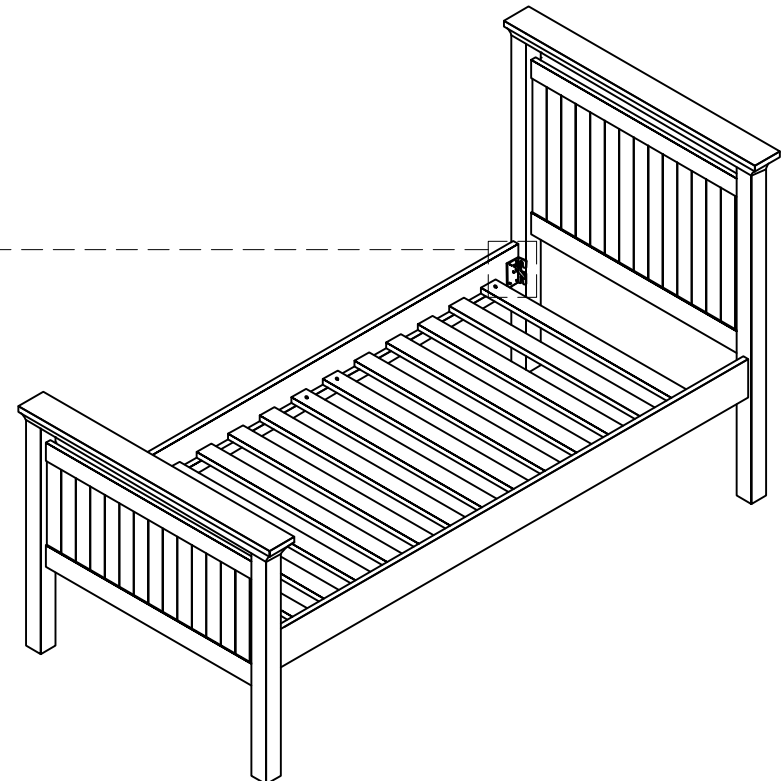
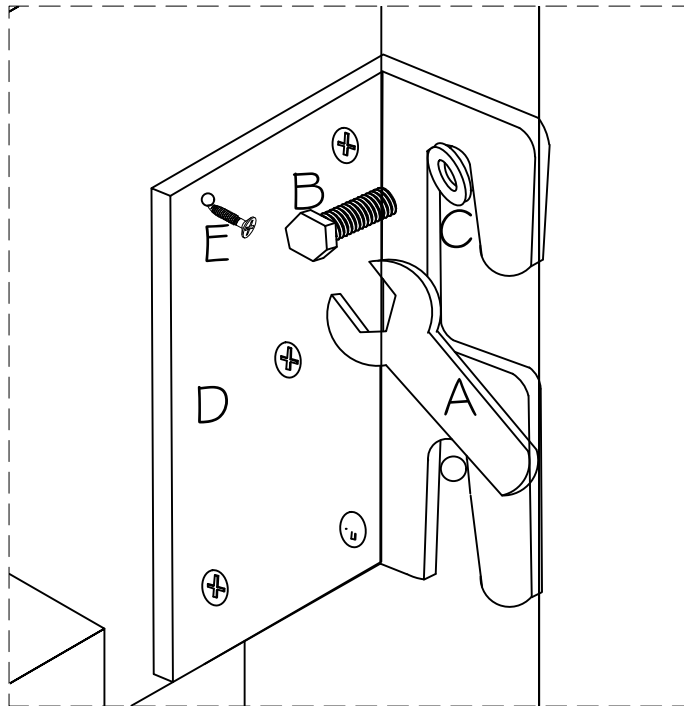

EXAMPLE FOR SKETCH ONLY

MADE IN MALAYSIA