

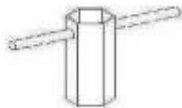

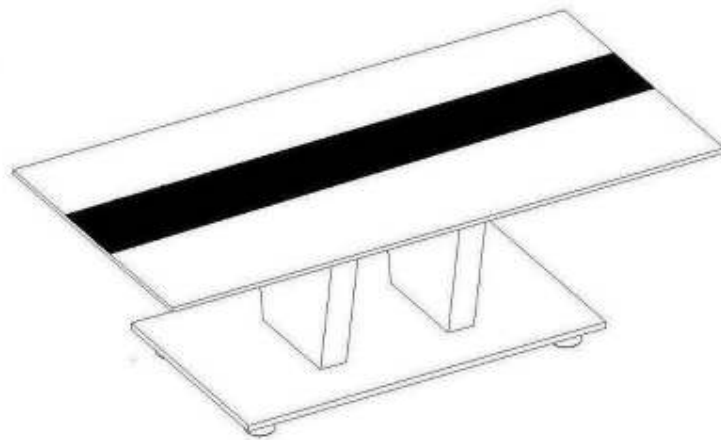





BETA COFFEE TABLE ASSEMBLY INSTRUCTIONS



1 X Spanner

<p>a</p>  <p>4 X Plastic washer ø8</p>	<p>b</p>  <p>4 X Metal washer ø8</p>	<p>c</p>  <p>4 X Spring washer ø8</p>	<p>d</p>  <p>4 X Nut ø8</p>
<p>e</p>  <p>4 X Foot ø8</p>	<p>f</p>  <p>4 X Threaded wire ø8* 410</p>		

STOP!

Before you start...

1

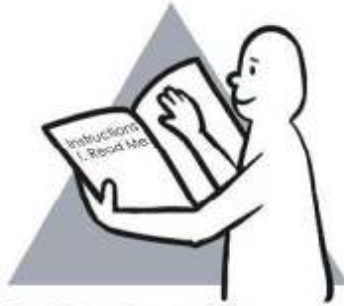

Read Instructions carefully.

2

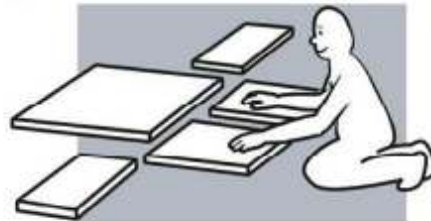

Lay out all of the components on a soft surface as if you were preparing to do a jigsaw puzzle.

3

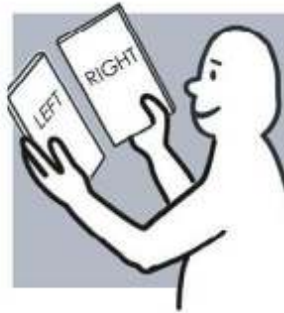

Carefully identify each component, especially those that are similar. The most common mistake is getting things back to front.

4



Separate and identify each component from the hardware pack and rest each one in its proper location before fastening.

5



DO NOT Over-tighten screws

6







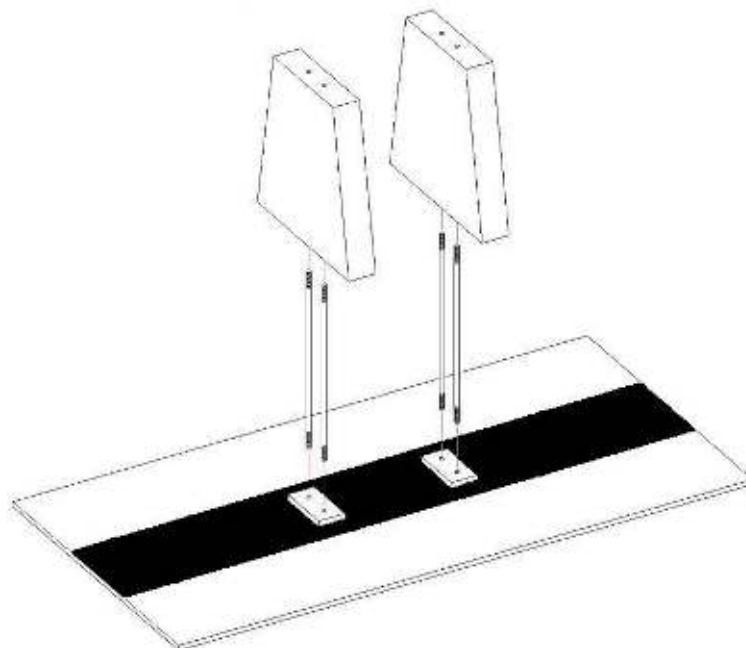
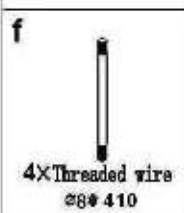

DO NOT set glue until you are certain that the parts belong together.

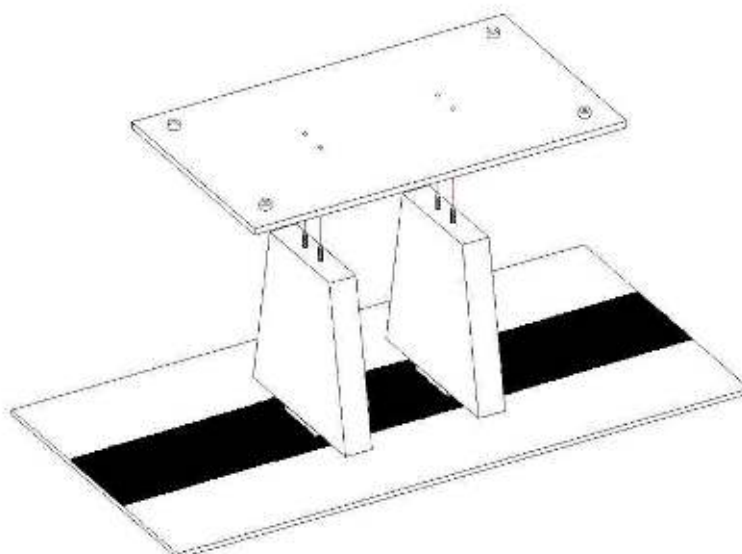



Step:1 Insert f(), into the position as shown and attach the stand



Step:2 Attach the bottom glass as shown



Step:3 Insert a() ,b() ,c() ,d() ,e() into position as shown

- a 
4X Plastic washer
ø8
- b 
4X Metal washer
ø8
- c 
4X Spring washer
ø8
- d 
4 X Nut
ø8
- e 
4 X Foot
ø8

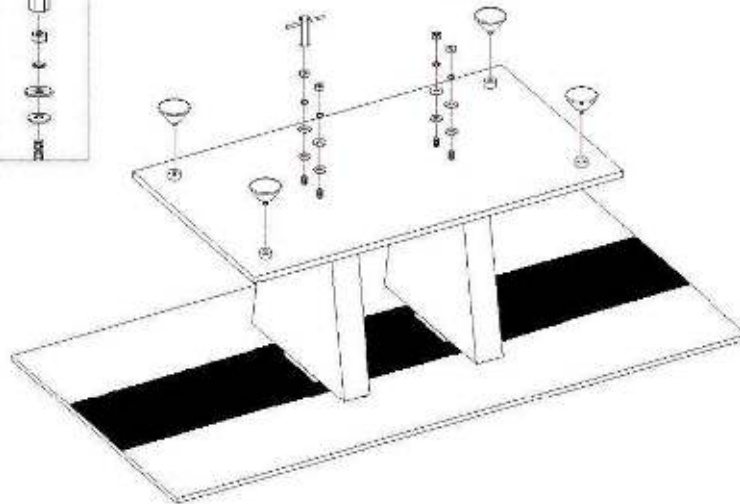
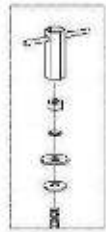

Step:4 Unit complete

