

ASSEMBLY INSTRUCTION

MODEL : HEPBURN (LOUIS PHILIP)
ITEM : BED (KING) .

NO	HARDWARE LIST	QTY
1	BOLT M8 X 18MM	8 PCS
2	SCREW M4 X 38MM	16 PCS

please follow this assembly instruction step by step

STEP 2

*NOTE : PLEASE REFER ASSEMBLY INSTRUCTION FOR CENTER SUPPORT.

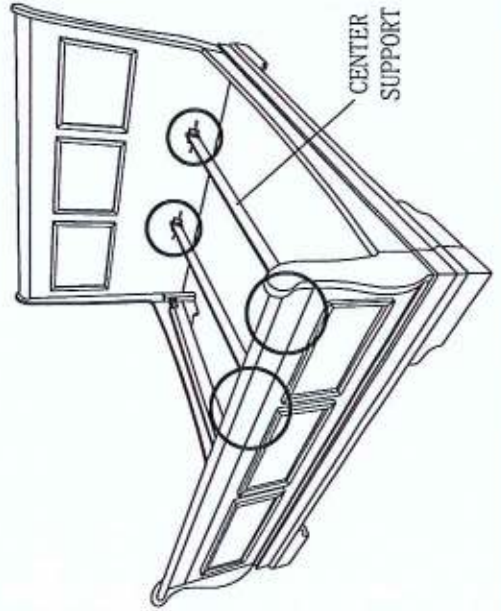

STEP 3

SCREW M4 X 38MM

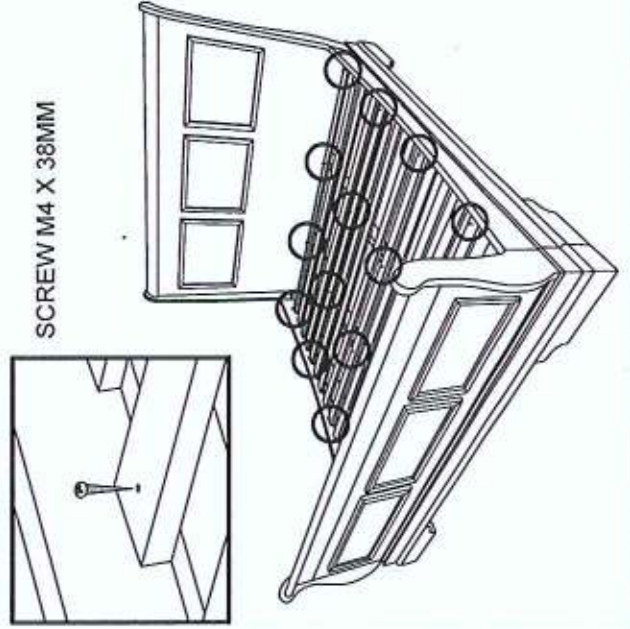

STEP 1

BOLT M8 X 18MM

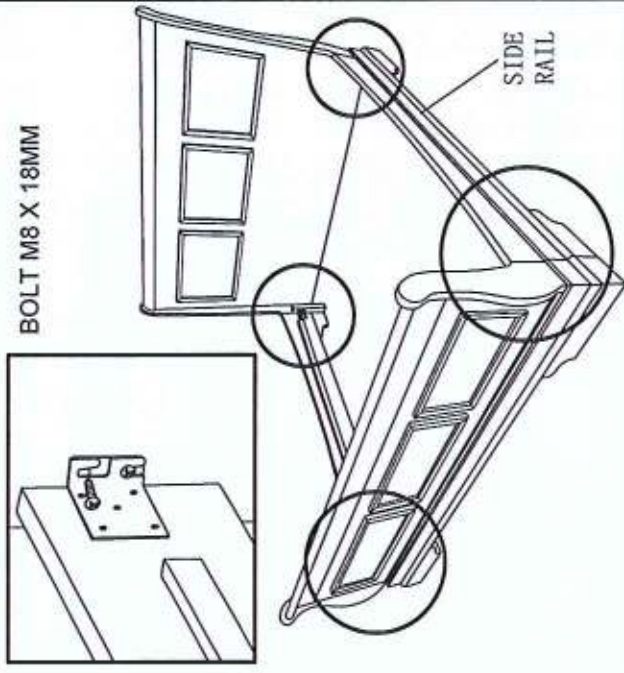

COMPLETE

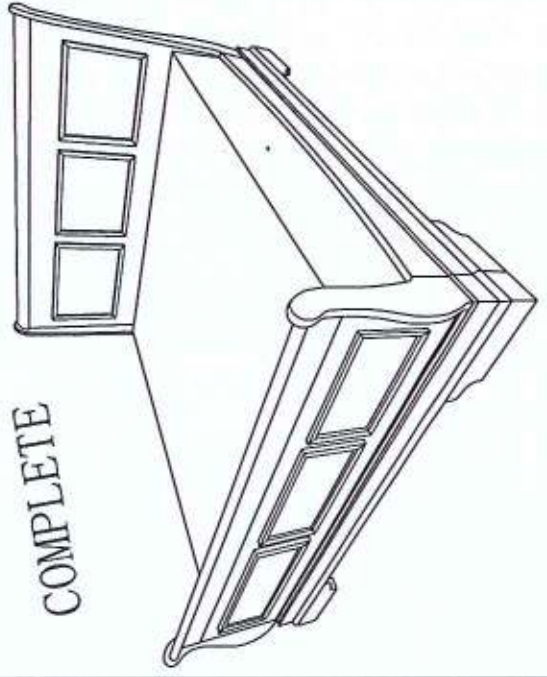

ASSEMBLY INSTRUCTION

ITEM : CENTER SUPPORT BED

(KING)

please follow this assembly instruction step by step

NO	HARDWARE LIST	QTY
1	JCRC M6 X 40MM	2 PCS
2	ALLEN KEY M6	1 PC
3	NUT	2 PCS
4	SCREW M3.5 X 16MM	8 PCS
5	U BRACKET	4 PCS
6	SCREW M4 X 20MM	8 PCS

STEP 1 U BRACKET AT THE HEADBOARD

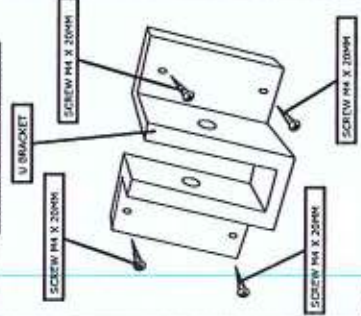

STEP 2 U BRACKET AT THE FOOTBOARD

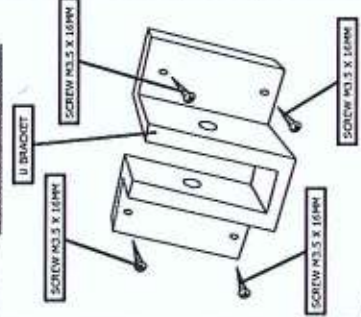

STEP 3

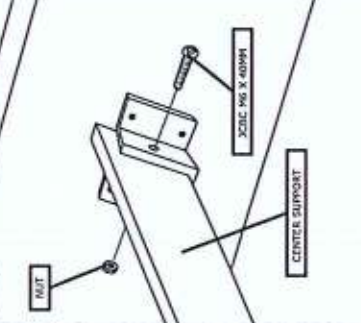

ASSEMBLY INSTRUCTION

ITEM : CENTER SUPPORT BED

(KING)

please follow this assembly instruction step by step

NO	HARDWARE LIST	QTY
1	JCRC M6 X 40MM	2 PCS
2	ALLEN KEY M6	1 PC
3	NUT	2 PCS
4	SCREW M3.5 X 16MM	8 PCS
5	U BRACKET	4 PCS
6	SCREW M4 X 20MM	8 PCS

STEP 1 U BRACKET AT THE HEADBOARD

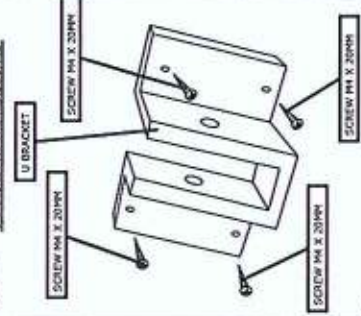

STEP 2 U BRACKET AT THE FOOTBOARD

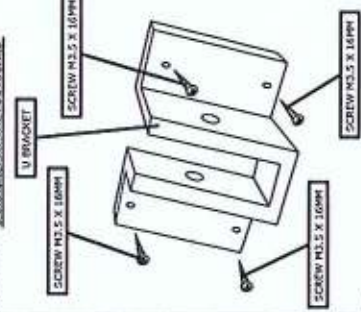

STEP 3

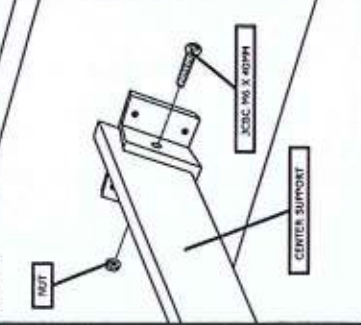

ASSEMBLY INSTRUCTION

ITEM : CENTER SUPPORT BED

(KING)

please follow this assembly instruction step by step

NO	HARDWARE LIST	QTY
1	JCRC M6 X 40MM	2 PCS
2	ALLEN KEY M6	1 PC
3	NUT	2 PCS
4	SCREW M3.5 X 16MM	8 PCS
5	U BRACKET	4 PCS
6	SCREW M4 X 20MM	8 PCS

STEP 1 U BRACKET AT THE HEADBOARD

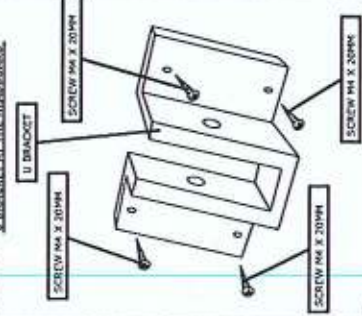

STEP 2 U BRACKET AT THE FOOTBOARD

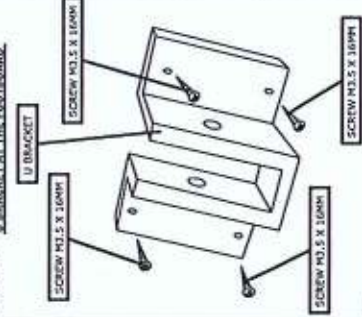

STEP 3

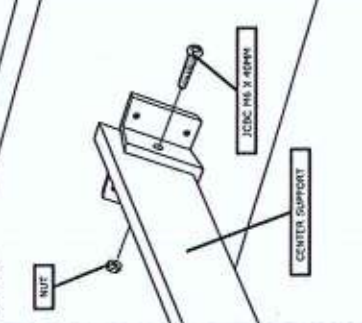

ASSEMBLY INSTRUCTION

ITEM : CENTER SUPPORT BED

(KING)

please follow this assembly instruction step by step

NO	HARDWARE LIST	QTY
1	JCRC M6 X 40MM	2 PCS
2	ALLEN KEY M6	1 PC
3	NUT	2 PCS
4	SCREW M3.5 X 16MM	8 PCS
5	U BRACKET	4 PCS
6	SCREW M4 X 20MM	8 PCS

STEP 1 U BRACKET AT THE HEADBOARD

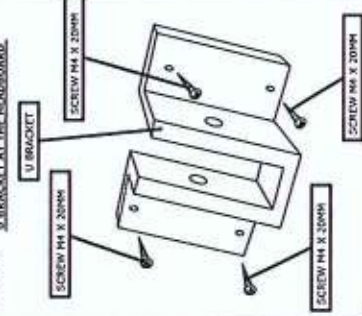

STEP 2 U BRACKET AT THE FOOTBOARD

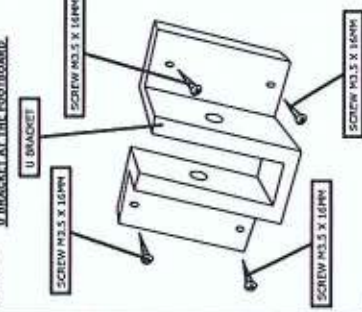

STEP 3

