

# ASSEMBLY INSTRUCTION

MODEL : HEPBURN  
 ITEM : BED (QUEEN)

NO	HARDWARE LIST	QTY
1	BOLT M8 X 18MM	8 PCS
2	SCREW M4 X 38MM	12 PCS

please follow this assembly instruction step by step

## STEP 1

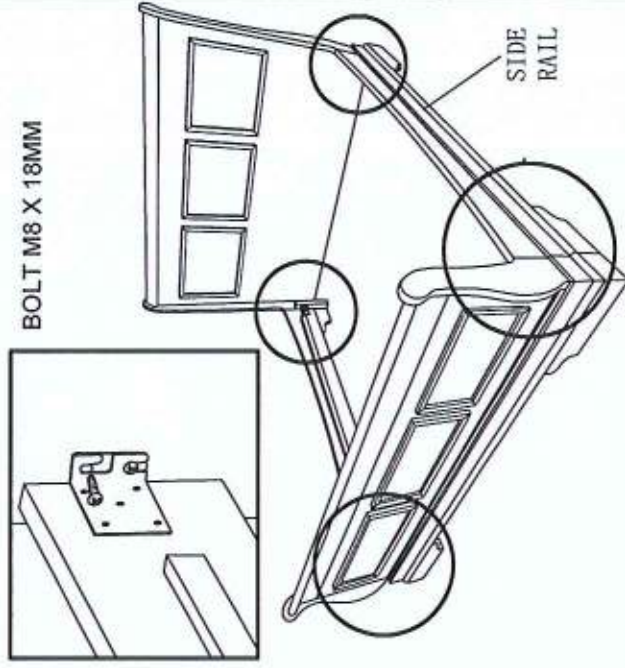

## STEP 2

\*NOTE : PLEASE REFER ASSEMBLY INSTRUCTION FOR CENTER SUPPORT.

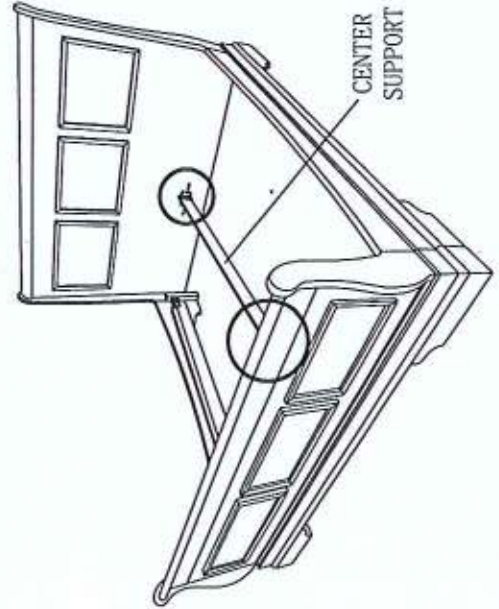

HEADBOARD

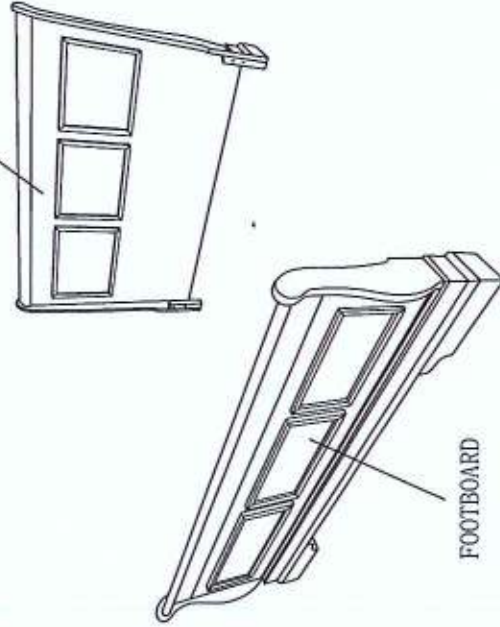

## STEP 3

SCREW M4 X 38MM

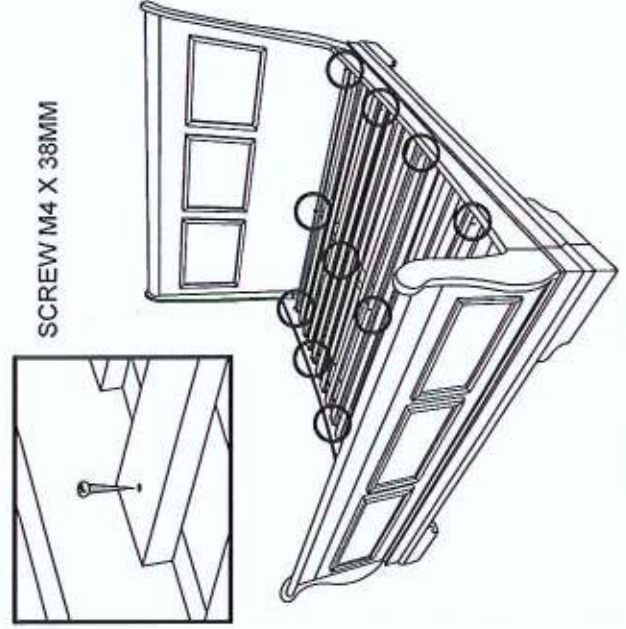

COMPLETE

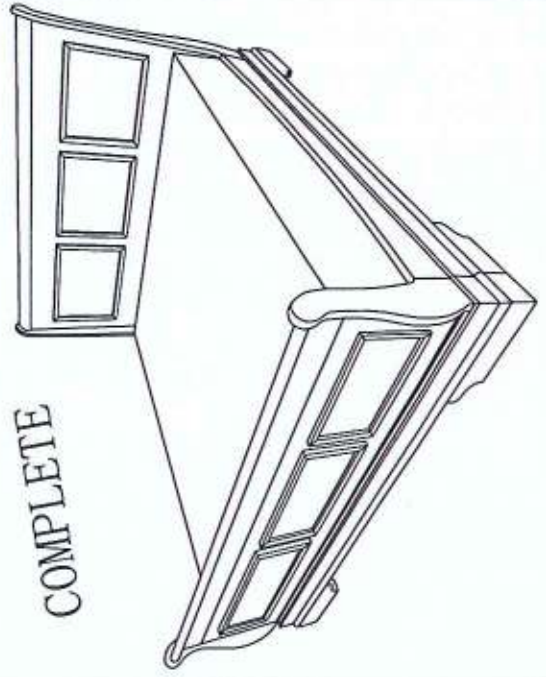

## ASSEMBLY INSTRUCTION

ITEM : CENTER SUPPORT BED  
(QUEEN)

please follow this assembly instruction step  
by step

NO	HARDWARE LIST	QTY
1	JCRC M6 X 40MM	2 PCS
2	ALLEN KEY M6	1 PC
3	NUT	2 PCS
4	SCREW M3.5 X 16MM	4 PCS
5	U BRACKET	2 PCS
6	SCREW M4 X 20MM	4 PCS

STEP 1 U BRACKET AT THE HEADBOARD.

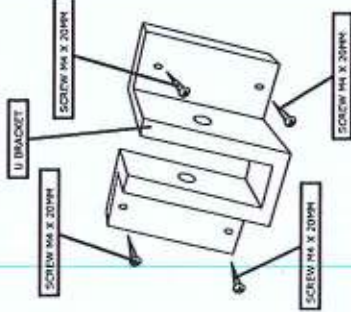

STEP 2 U BRACKET AT THE FOOTBOARD.

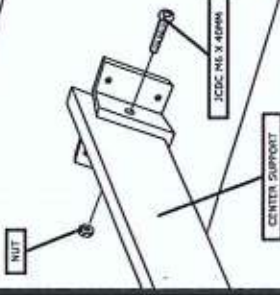
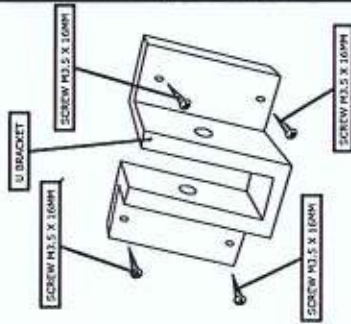

## ASSEMBLY INSTRUCTION

ITEM : CENTER SUPPORT BED  
(QUEEN)

please follow this assembly instruction step  
by step

NO	HARDWARE LIST	QTY
1	JCRC M6 X 40MM	2 PCS
2	ALLEN KEY M6	1 PC
3	NUT	2 PCS
4	SCREW M3.5 X 16MM	4 PCS
5	U BRACKET	2 PCS
6	SCREW M4 X 20MM	4 PCS

STEP 1 U BRACKET AT THE HEADBOARD.

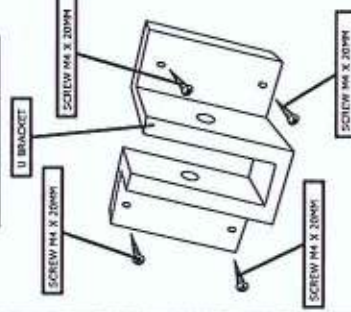

STEP 2 U BRACKET AT THE FOOTBOARD.

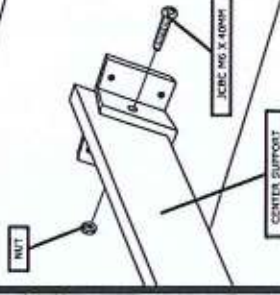
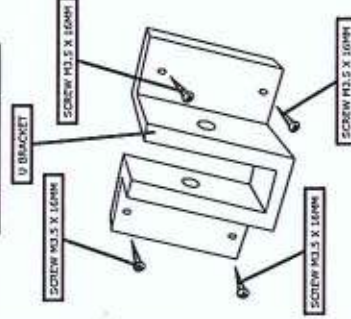

## ASSEMBLY INSTRUCTION

ITEM : CENTER SUPPORT BED  
(QUEEN)

please follow this assembly instruction step  
by step

NO	HARDWARE LIST	QTY
1	JCRC M6 X 40MM	2 PCS
2	ALLEN KEY M6	1 PC
3	NUT	2 PCS
4	SCREW M3.5 X 16MM	4 PCS
5	U BRACKET	2 PCS
6	SCREW M4 X 20MM	4 PCS

STEP 1 U BRACKET AT THE HEADBOARD.

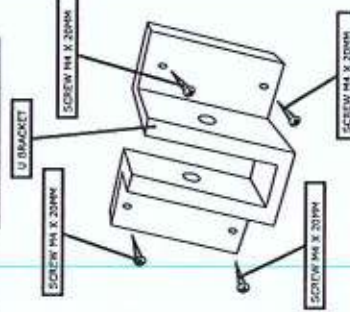

STEP 2 U BRACKET AT THE FOOTBOARD.

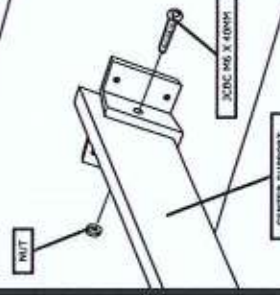
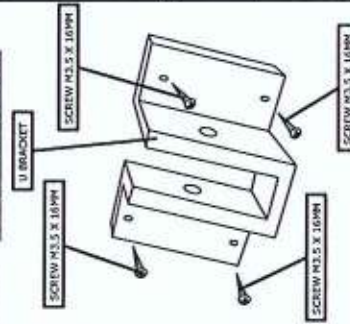

## ASSEMBLY INSTRUCTION

ITEM : CENTER SUPPORT BED  
(QUEEN)

please follow this assembly instruction step  
by step

NO	HARDWARE LIST	QTY
1	JCRC M6 X 40MM	2 PCS
2	ALLEN KEY M6	1 PC
3	NUT	2 PCS
4	SCREW M3.5 X 16MM	4 PCS
5	U BRACKET	2 PCS
6	SCREW M4 X 20MM	4 PCS

STEP 1 U BRACKET AT THE HEADBOARD.

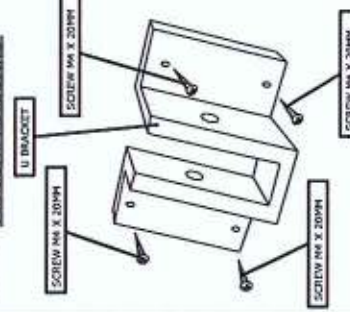

STEP 2 U BRACKET AT THE FOOTBOARD.

