

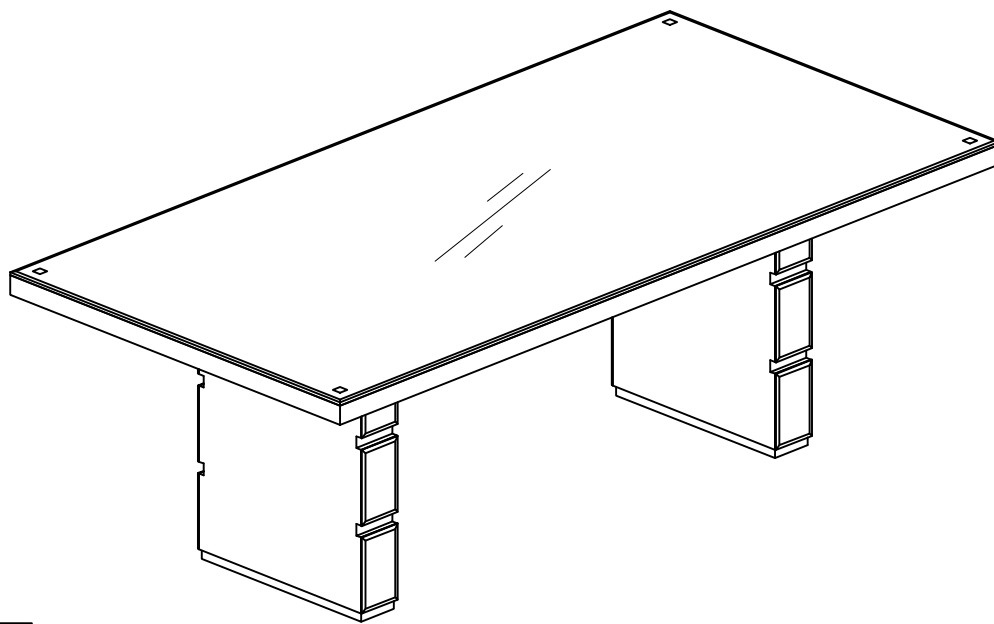

GS1000 DINING TABLE ASSEMBLY INSTRUCTIONS

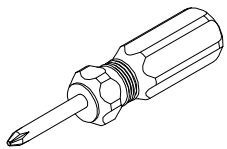

Using Tools



1xScrewdriver

Page: 1

A

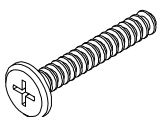

4xThreaded
wireM6*45

B

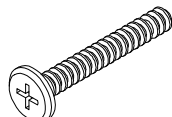

4xThreaded
wireM8*60

C

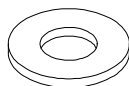

4xWasher
Ø8

D

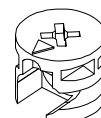

16xCam
Bolts

E

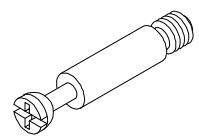

16xCam
Nuts

STOP!

Before you start...

1



Read Instructions carefully.

2

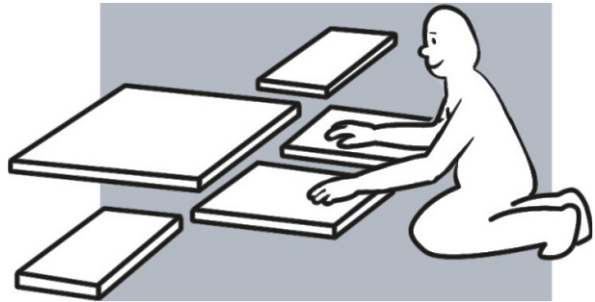

Lay out all of the components on a soft surface as if you were preparing to do a jigsaw puzzle.

3



Carefully identify each component, especially those that are similar. The most common mistake is getting things back to front.

4



Separate and identify each component from the hardware pack— and rest each one in its proper location before fastening.

5

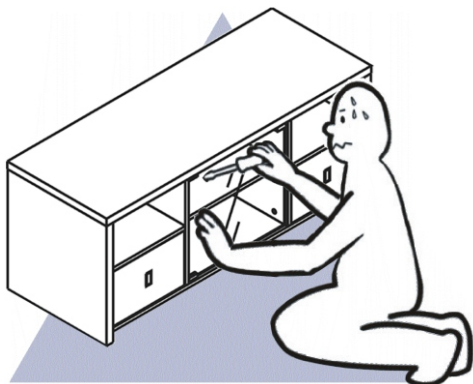

DO NOT Over-tighten screws

6



DO NOT set glue until you are certain that the parts belong together.

Step 1: Connect two legs to the panels with D () and E () as shown.

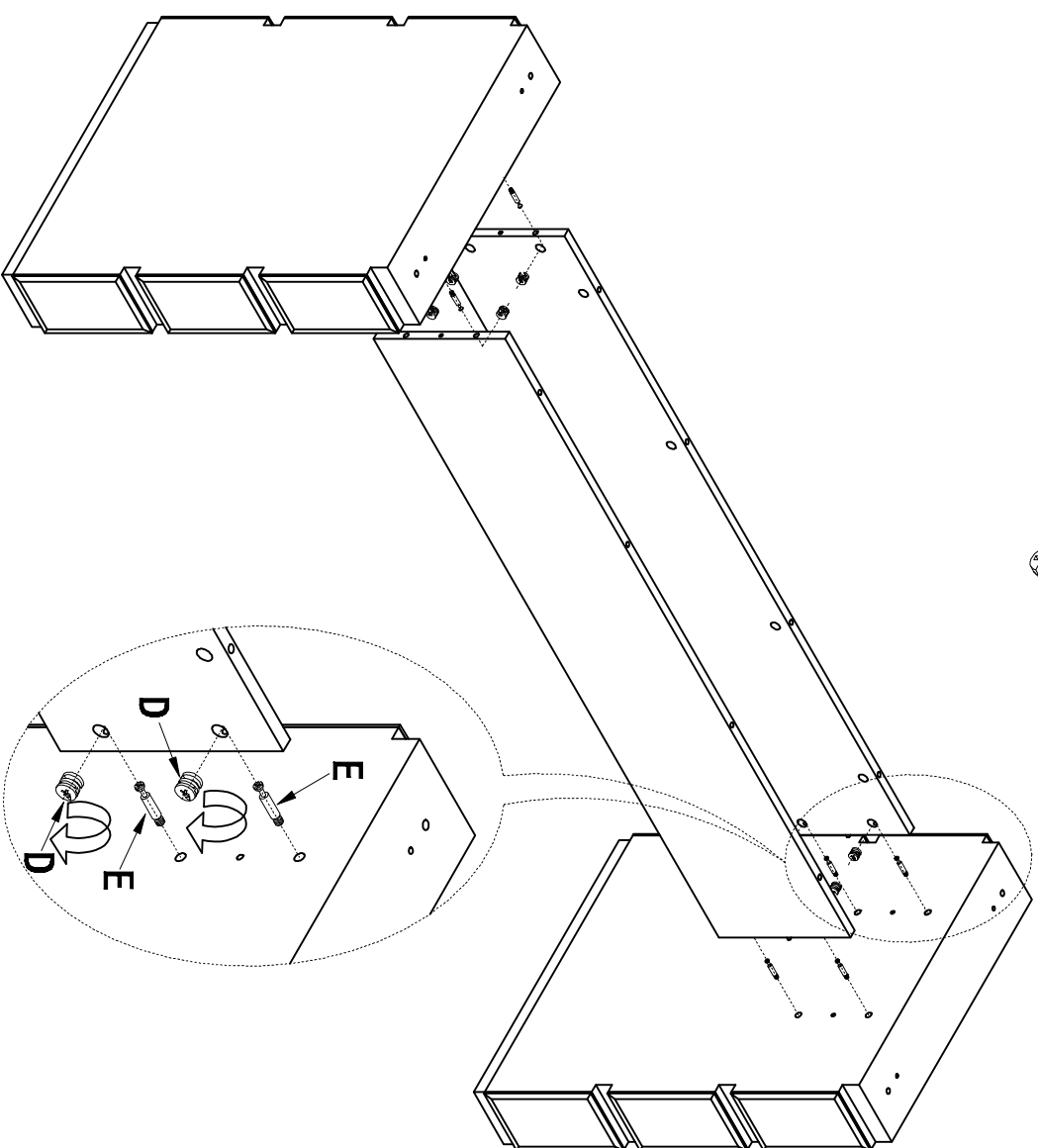

D

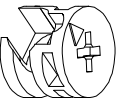

8xCam Bolts

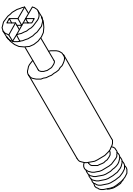

E





8xCam Nuts

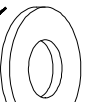

Step 2:

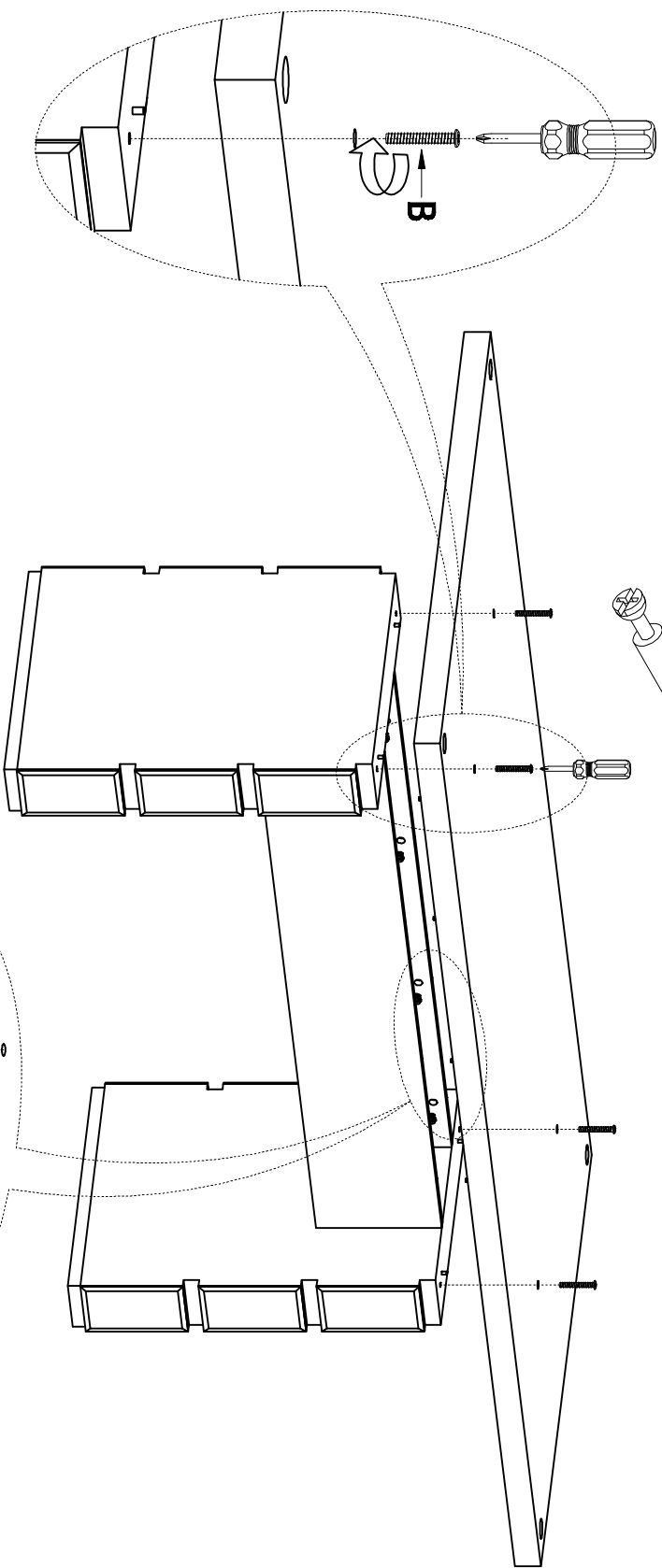
Attach the top panel and bottom legs with B () C (), D () cam bolts and E () cam nuts as shown.

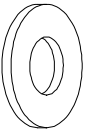
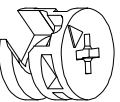
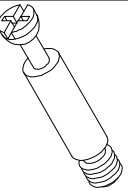

B  4x Threaded wire M8*60	C  4x Washer Ø8	D  8x Cam Bolts	E  8x Cam Nuts
---	---	---	--

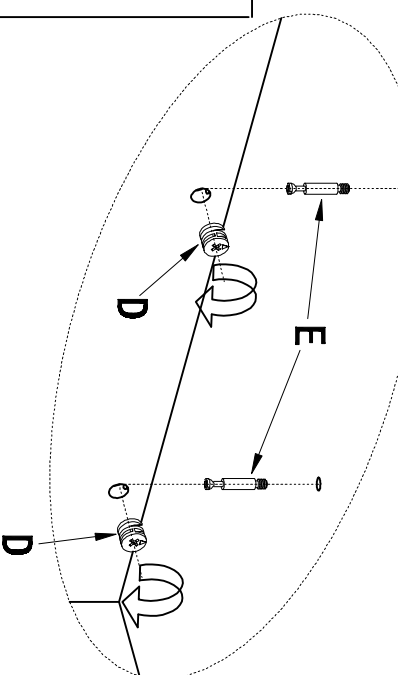

Step 3: Attach the top glass to the top panel with A () threaded wire as shown.

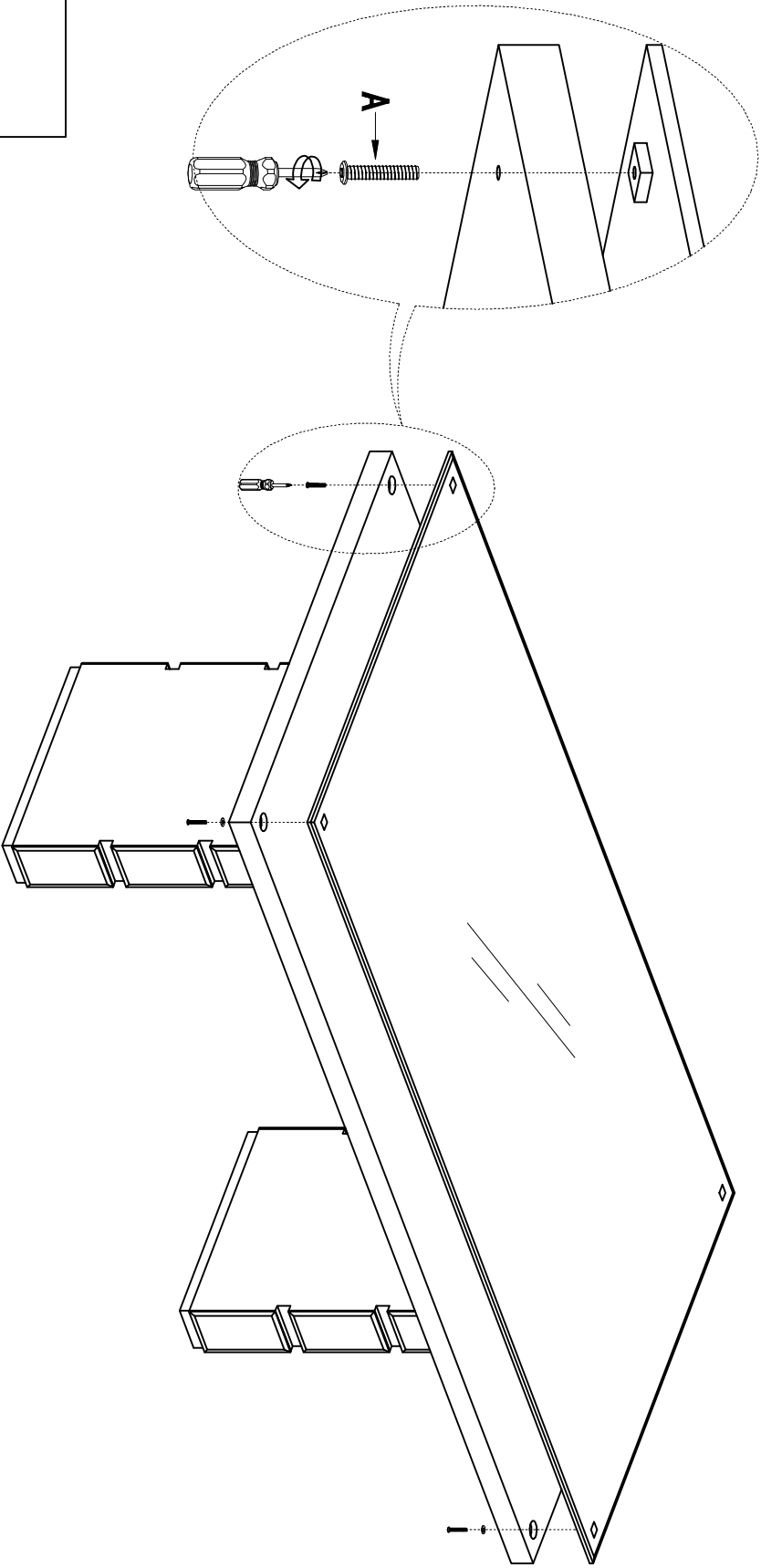

4x Threaded
wire M6*45

A

UNIT COMPLETE

