

PALERMO COFFEE TABLE ASSEMBLY INSTRUCTIONS

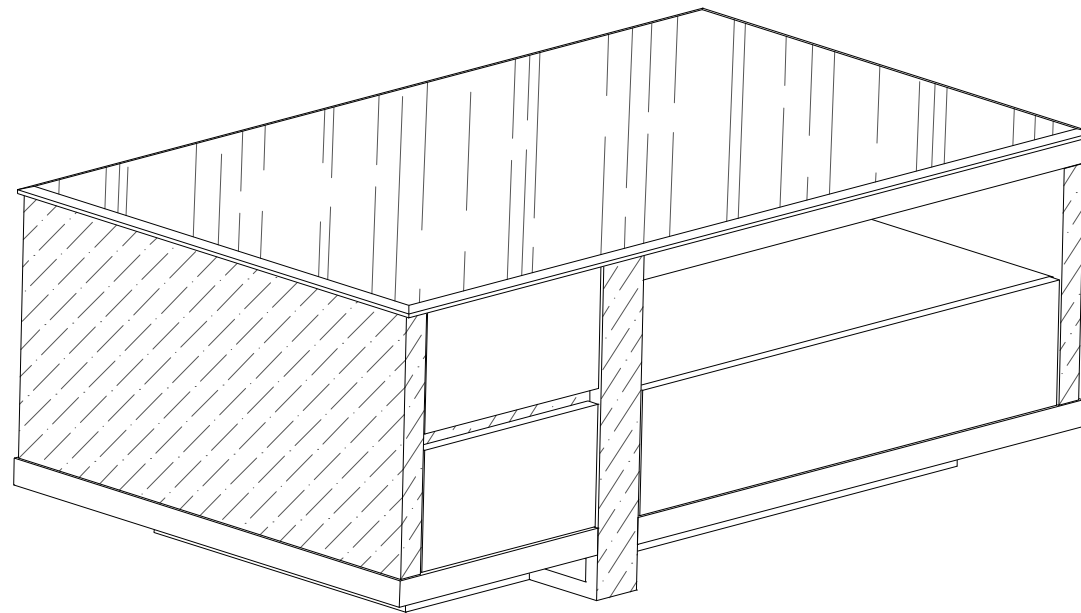

2xThreaded
re M6*30

Page 1



STOP!

Before you start...

1



Read Instructions carefully.

2

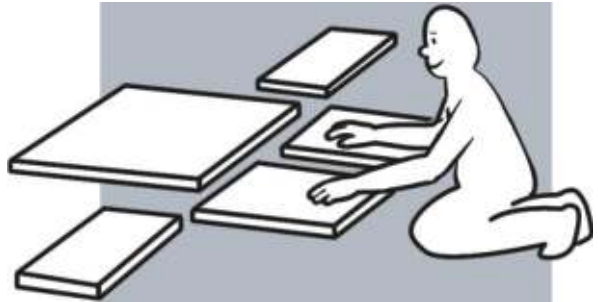

Lay out all of the components on a soft surface as if you were preparing to do a jigsaw puzzle.

3

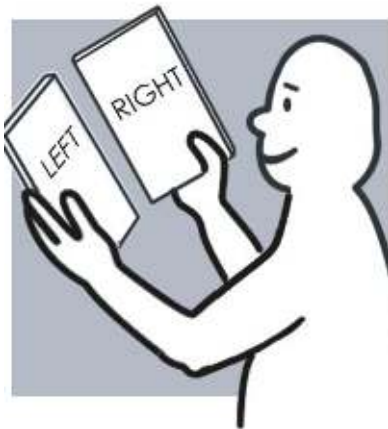

Carefully identify each component, especially those that are similar. The most common mistake is getting things back to front.

4



Separate and identify each component from the hardware pack— and rest each one in its proper location before fastening.

5



DO NOT Over-tighten screws

6

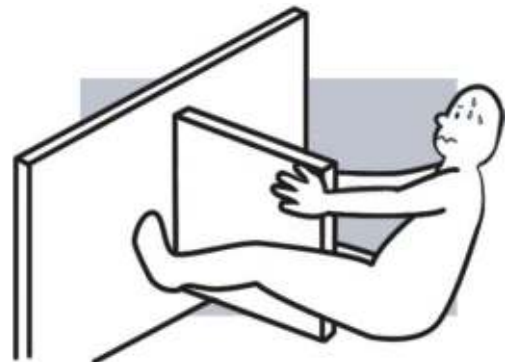

DO NOT set glue until you are certain that the parts belong together.

PALCT

Step 1: a .Put the glass top on the coffee table and fix the glass top to the panel with A() threaded wire as shown.

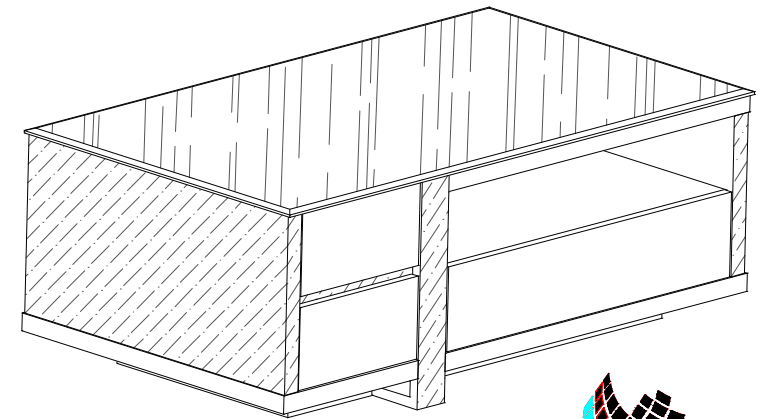
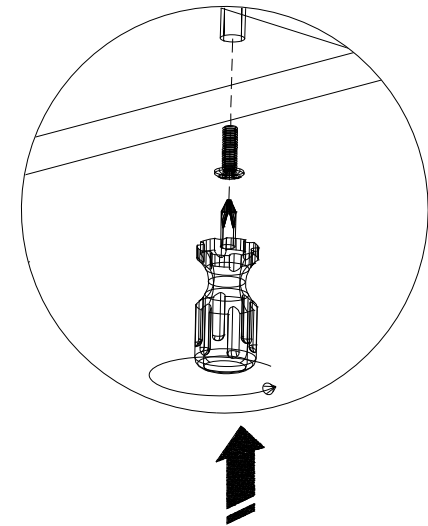
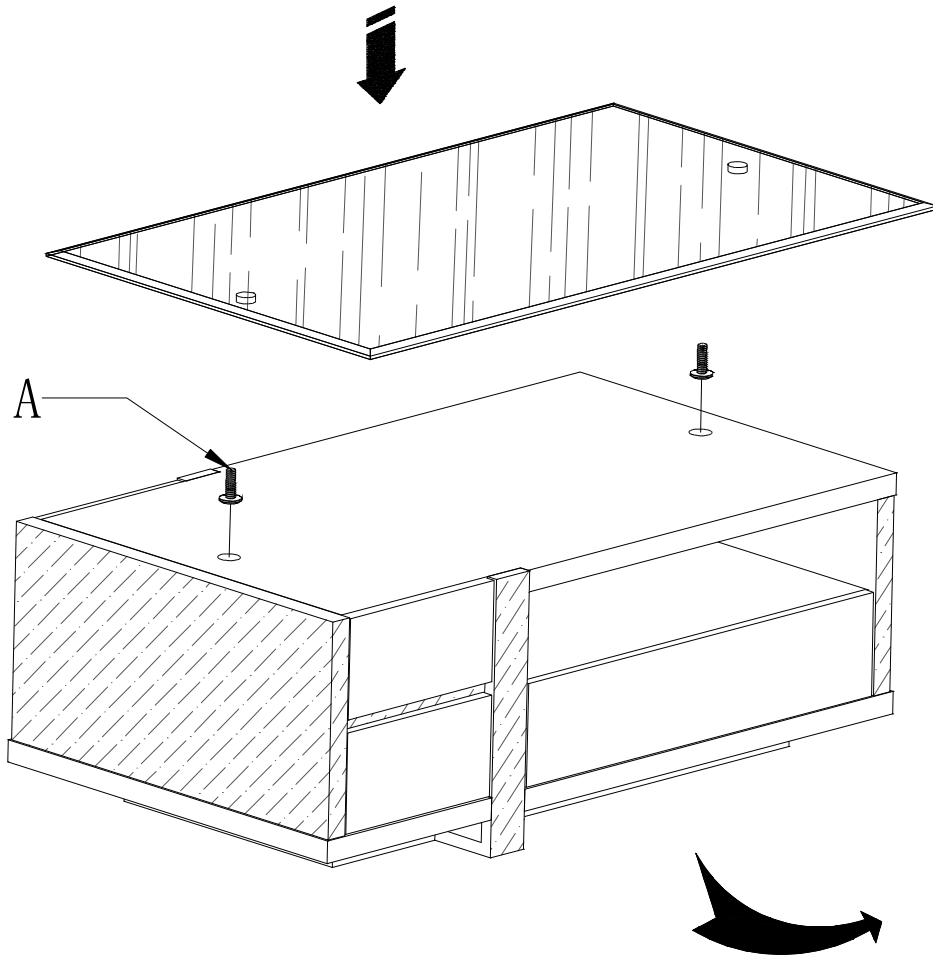

A. 2xThreaded
wire M8*30

PALERMO COFFEE TABLE COMPLETE

