

SANTORINI DINING TABLE ASSEMBLY INSTRUCTIONS

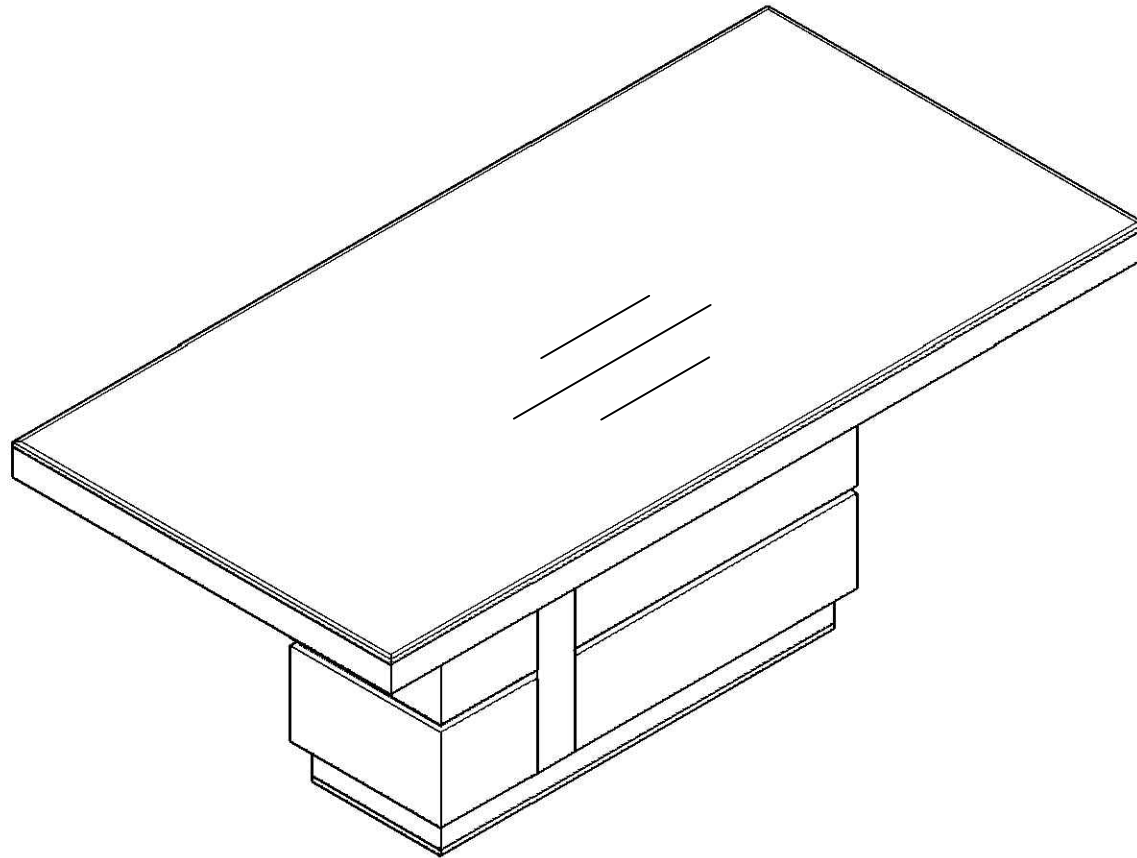

Using Tools

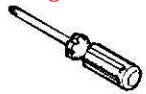

1xScrewdriver

A



16xThreaded wire
M6x30

B

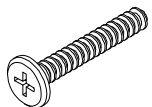

4xThreaded wire
M6*45

C

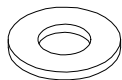

4xWasher
Ø8

STOP!

Before you start...

1



Read Instructions carefully.

2

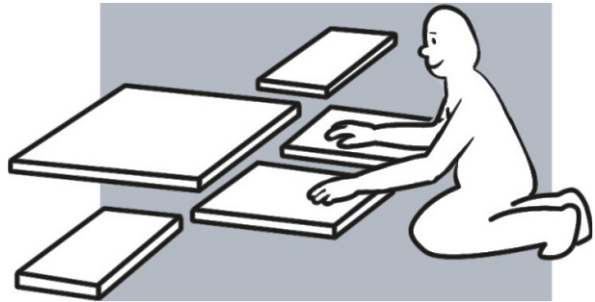

Lay out all of the components on a soft surface as if you were preparing to do a jigsaw puzzle.

3

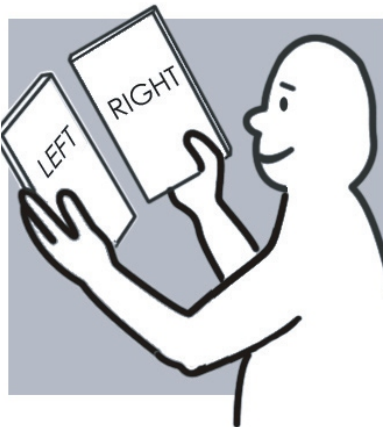

Carefully identify each component, especially those that are similar. The most common mistake is getting things back to front.

4



Separate and identify each component from the hardware pack— and rest each one in its proper location before fastening.

5

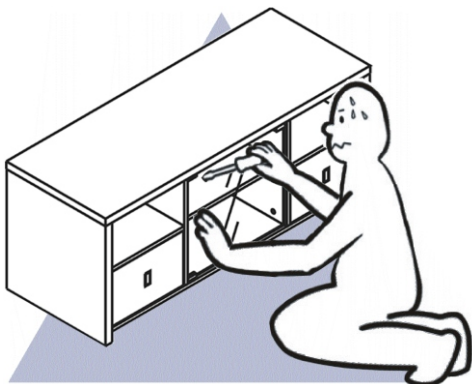



DO NOT Over-tighten screws

6



DO NOT set glue until you are certain that the parts belong together.

Step1:Use screwdriver() attach the support panel to the main body with A() threaded wire as shown.

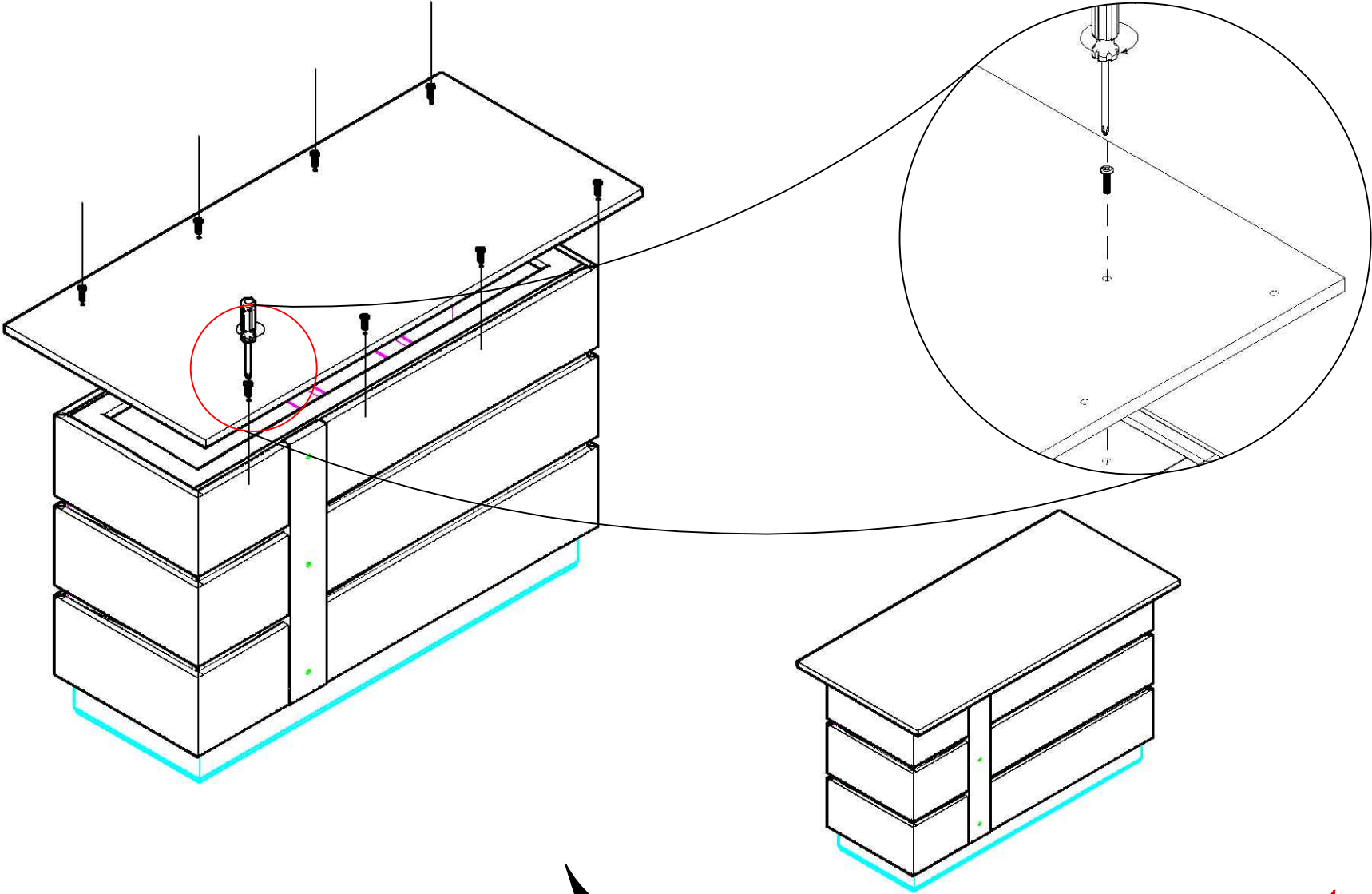

Using Tools



1xScrewdriver



A. 8xThreaded wire
M6x30

Step 2: Use screwdriver() attach the top panel to the main body with A() threaded wire as shown.

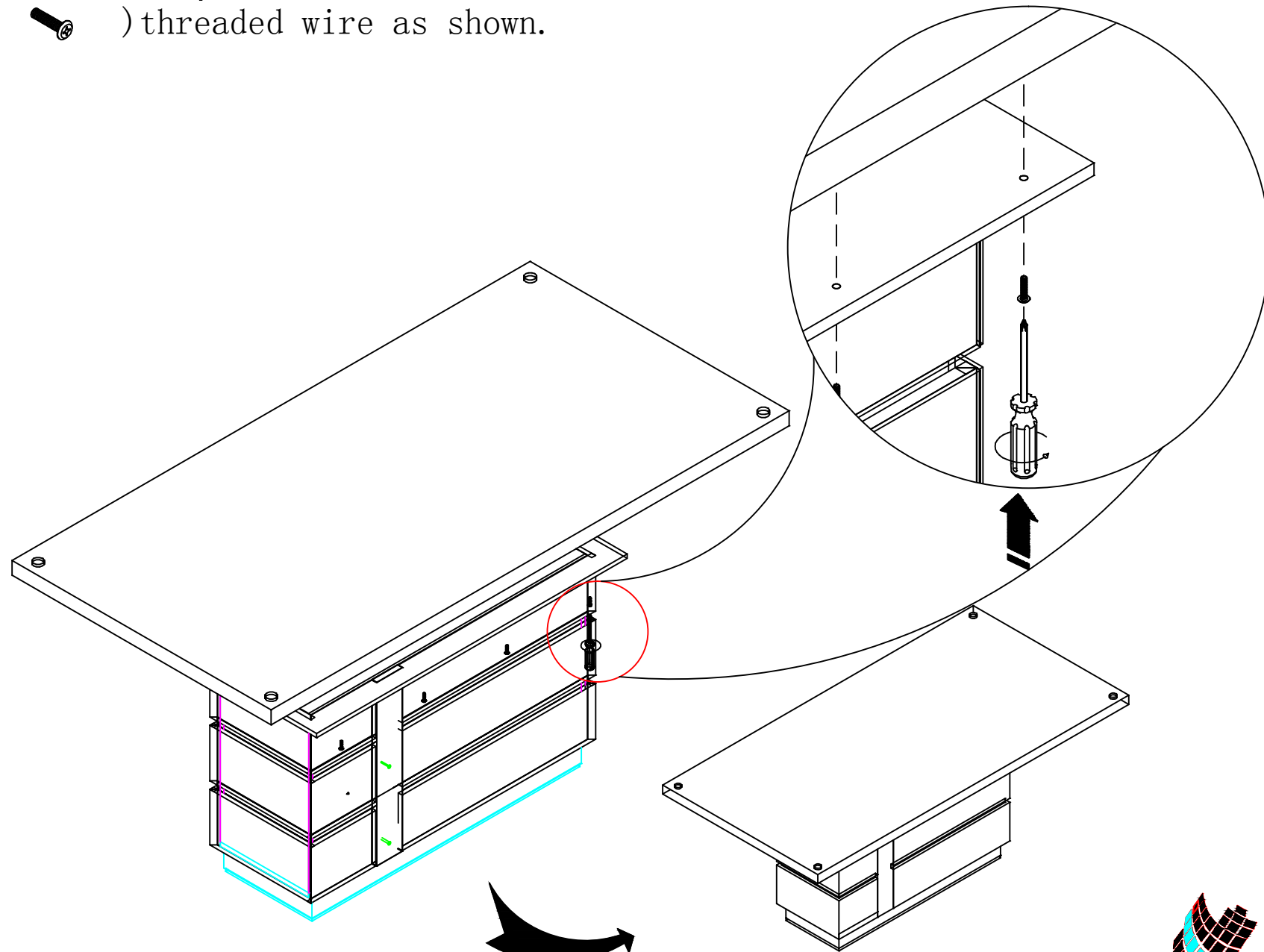



Using Tools



1xScrewdriver

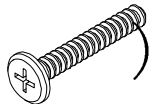

A. 8xThreaded wire
M6x30

Step 3: Attach the top glass to the top panel with B() threaded wire and C() washers as shown.

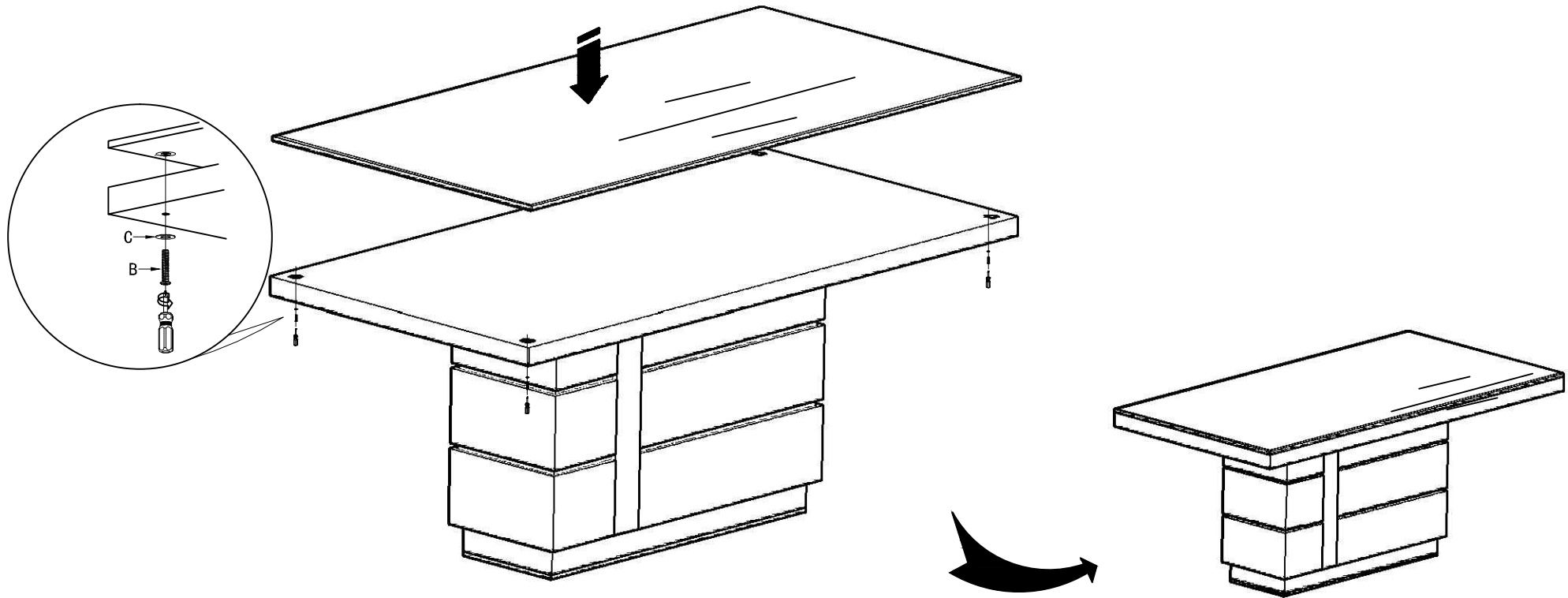

B

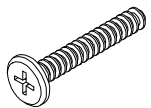

4x Threaded wire
M6*45

C

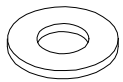

4x Washer
Ø8

SANTORINI DINING TABLE

UNIT COMPLETE

